

## KRAIBURG Soft Bed LongLine

### prerequisites:



#### concrete area:

- no holes
- no elevations
- with at least a 3 % slope

#### mats:

even temperature: minimum 5° C to maximum 30° C (store according to initial temperature)

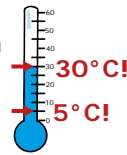

For animal well-being some litter is necessary to absorb moisture! (e.g. soft milled straw or mineral material)

### You will need this:

#### measuring:

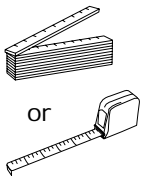

#### marking:

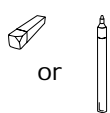

#### cutting:

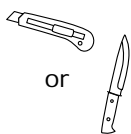

#### drilling and installing:

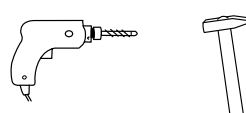

#### KRAIBURG fastening elements:



- nail plugs  $\varnothing$  8 x 60 mm - A2
- washers  $\varnothing$  22 mm - A2
- nail plugs  $\varnothing$  10 x 80 mm - A2
- washers  $\varnothing$  30 mm - A2

(or fastening elements with at least the same resistance and durability)

## 1 Lay out and fasten sealing strips at the rear edge

- > thin, wide sealing strips (11 mm thick, about 20 cm wide)
- > nail plugs 8 x 60 mm

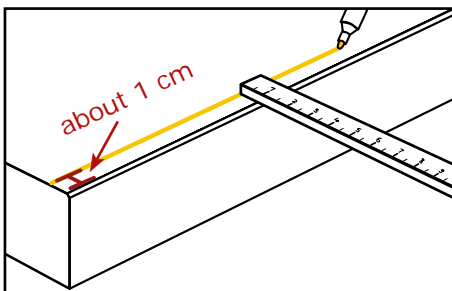

mark a approx. 1 cm distance from the rear concrete edge



**tip:**  
use a chalk line!

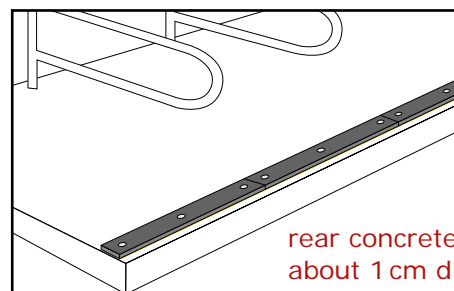

lay out thin, wide sealing strips along the marking

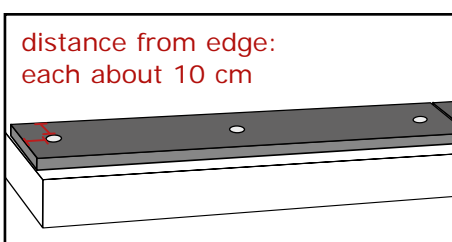
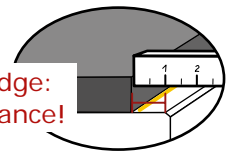

distance from edge:  
each about 10 cm

fasten each sealing strip 3 x



**8 x 60 mm!**

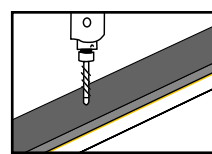

drill

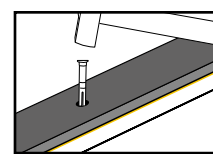

pound the plastic plugs in flush

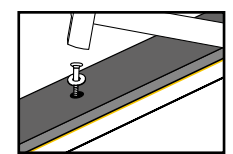

pound in nails and washers

## 2 Lay out side sealing strips - foam - front sealing strips

- > thick, narrow sealing strips (18 mm thick, about 5 cm wide)
- > foam

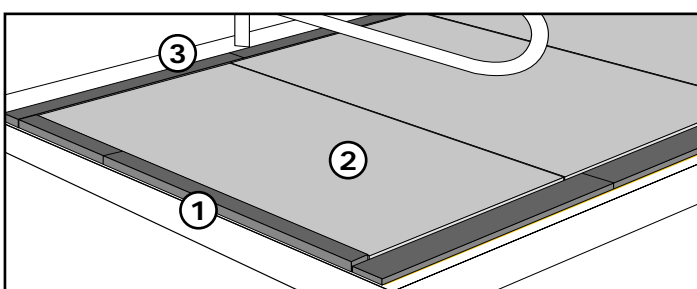

1 lay out thick, narrow sealing strips along the side edges - shorten sealing strips accordingly

2 place foam smoothly along rear and side sealing strips

3 lay thick, narrow sealing strips loosely edge to edge against foam



### 3 Roll out rubber cover

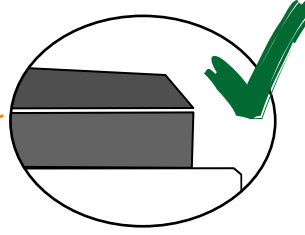
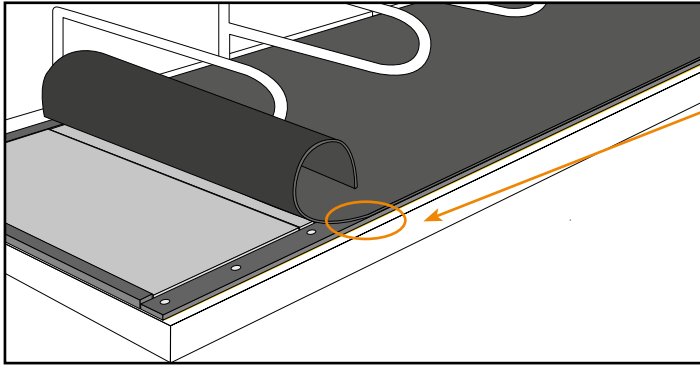

flush with the rear  
sealing strip

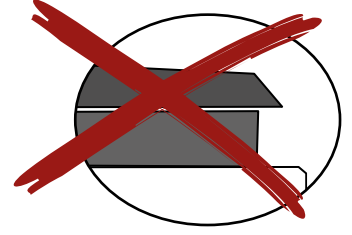

rubber cover may  
not overlap rear-  
wards

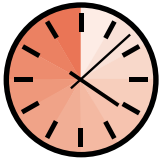

let the rolled out rubber cover rest in the house climate  
for **at least 12 hours** (-> to relieve tension)

### 4 Fastening

> nail plugs 10 x 80 mm

**i** start in the middle of the rubber cover and alternately work towards the right and to the left

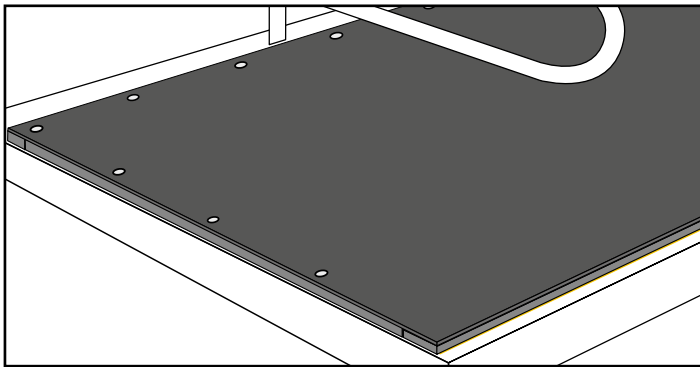

fasten through rubber cover and sealing strips **at the front and side edge**

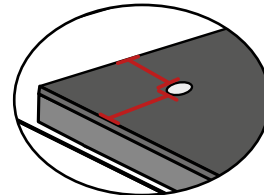

distance from  
edge: each about  
2.5 cm

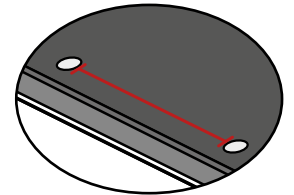

distance between  
fastenings:  
about 40 cm

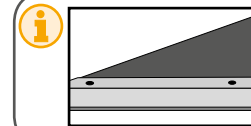

**i** If using a steel bar (addi-  
tional charge!) all distances  
are fixed through the precut  
holes.

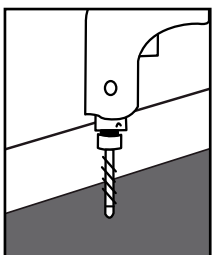

drill

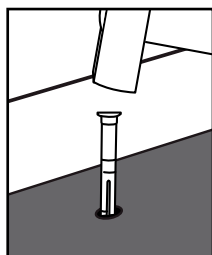

pound the  
plastic plugs in  
flush

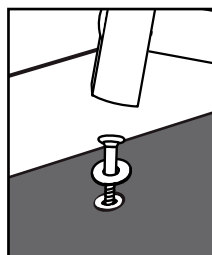

pound in nails and washers until  
they are seated evenly fast and  
are slightly countersunk